

# Data Sheet



Article number: 03706016

Description: Fluro rod end BRF 16  
with ball bearing

## Measures

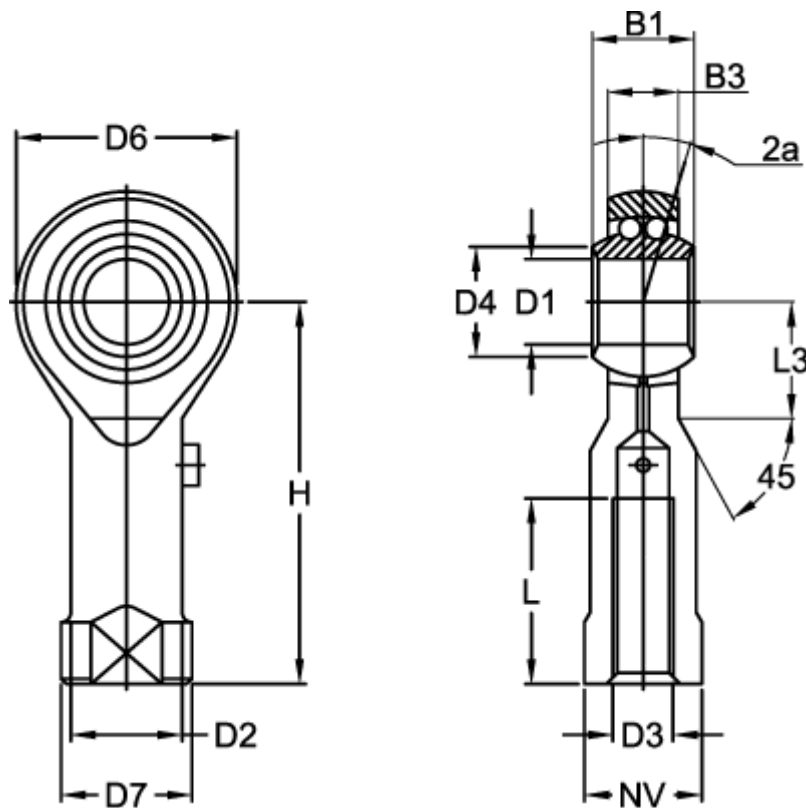

Angel 2a = 8.0	D7	= 27
B1 = 21	Dynamic load C (N)	= 6250
B3 = 15.00	H	= 64
D1 = 16	L	= 28
D2 = 22.0	L3	= 22
D3 = M16x2	Max rpm	= 975
D4 = 19.0	NV	= 22
D6 = 42	Static load (N)	= 2350

Weight (kg) = 0.224